

WACKER

CREATING TOMORROW'S SOLUTIONS

VINNAPAS®

POLYMER SPECIALTIES | BINDERS AND ADDITIVES

**VINNAPAS® SOLID RESINS –
CLEAR ADVANTAGES FOR YOUR
APPLICATION**

WHY NOT ADD A BUNCH OF BENEFITS TO YOUR FORMULATION?

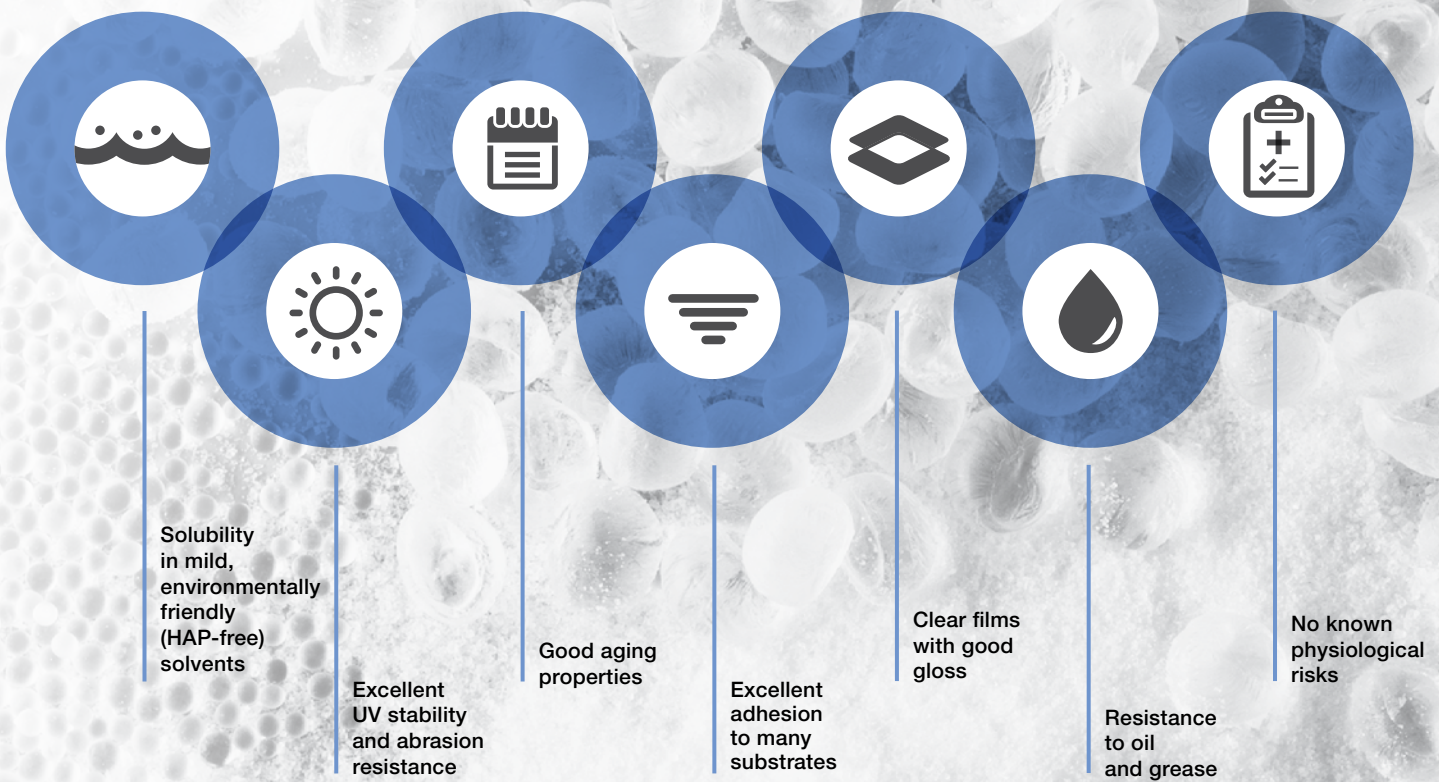

VINNAPAS® is a registered trademark of Wacker Chemie AG.

VINNAPAS® solid resins are thermo-plastic polyvinyl acetates (PVAc) with an attractive property profile:

- Homogeneous
- Color-free
- Odor-free
- Taste-free
- No known physiological risks

Open for New Applications

The versatile polymers are already used as binders and/or as additives, for example, in the following applications:

- Low-profile additives
- Solvent-based adhesives
- Hot-melt adhesives
- Structural adhesives
- Coatings
- Sound-damping sheets
- Powder injection molding (PIM)

But many other application fields are feasible, too. Whether you need to prevent unsaturated polyesters from shrinking during curing, to improve the adhesion of your product to certain surfaces or if you are looking for a crystal-clear alternative to natural resins: our broad portfolio offers many possibilities. Talk to us!

Contents

General Product Information

Chemical Structure	4
VINNAPAS® Product Overview	6
Solubility Tables and Compatibility	8

Applications

VINNAPAS® Application Areas	12
Low-Profile Additives	14
Adhesives	16
Coatings	19
Sound-Damping Sheets	20
Powder Injection Molding (PIM)	21

VINNAPAS® General Information

WACKER at a Glance	23
--------------------	----

BRING YOUR IDEAS TO LIFE WITH THE BROADEST OFFERING OF PVAC RESINS

WACKER is the leading supplier of polyvinyl acetate solid resins. We offer you decades of experience with PVAc chemistry and – under the brand name VINNAPAS® – the most comprehensive range of PVAc resin products.

WACKER offers a uniquely diverse portfolio of PVAc resins because we have the capability to produce different VINNAPAS® grades by varying the:

- Monomers
- Polymerization processes
- Molecular weights
- Viscosities in solution

Choose Different Chemical Structures for Different Properties

As shown in the diagram, WACKER offers different grades of PVAc resins: homopolymers, such as VINNAPAS® B and UW grades; carboxylated PVAc, VINNAPAS® C grades (copolymer of vinyl acetate and crotonic acid) and VINNAPAS® VL grades (copolymers of vinyl acetate and vinyl laurate*).

Unique Grades

VINNAPAS® VL grades, specialties consisting of PVAc and vinyl laurate (VL) monomer, are exclusively produced by Wacker Chemie AG.

Benefit from Different Production Processes that Unlock a Broader Range of Properties

WACKER produces VINNAPAS® solid resins by three processes:

- Bulk polymerization
- Solution polymerization
- Suspension polymerization

VINNAPAS® PVAc Homopolymer Grades

Low-to-medium molecular weight:
VINNAPAS® B grades

- PVAc homopolymers with low-to-medium molecular weight
- High-purity, food-grade quality

High molecular weight:
VINNAPAS® UW grades

- PVAc homopolymers with high molecular weight
- Broad range of binders; variable molecular weight and viscosities

VINNAPAS® C Copolymer Grades

Carboxylated PVAc:
VINNAPAS® C grades

- Carboxylated PVAc (crotonic acid as functional monomer)
- Promote adhesion to metals

VINNAPAS® VL Copolymer Grades

Copolymers with vinyl laurate*:
VINNAPAS® VL grades

- Copolymers with vinyl laurate
- Impart high flexibility, hydrophobicity (promote water resistance), biocontent

* Vinyl laurate products are marketed by Wacker Chemie AG under the brand name VERSA® 12.

CHOOSE THE BEST VINNAPAS® FOR YOUR APPLICATION!



Enjoy more formulation freedom!

This variety makes it easy to find not just any grade, but the best grade for your specific application. If in doubt, please contact your WACKER expert.

VINNAPAS® SOLID RESINS

PRODUCT OVERVIEW

Product Properties at a Glance

Grades	Viscosity ¹ [mPa s]	Acid Number ² [mg KOH/g]	Delivery Form	Volatiles ³ [%]	Molecular Weight ⁴ [Mw g/mol]
VINNAPAS® Homopolymer Polyvinyl Acetate (CAS No. 9003-20-7)					
VINNAPAS® B Grades⁹					
VINNAPAS® B 1.5 SP	1.2 – 1.4	< 0.5	Pastilles	< 1.0	~15,000
VINNAPAS® B 5 SP	1.6 – 2.0	< 0.5	Pastilles	< 1.0	~25,000
VINNAPAS® B 14 SP	1.9 – 2.3	< 0.5	Pastilles	< 1.0	~35,000
VINNAPAS® B 17 SP	2.5 – 3.0	< 0.5	Pellets	< 1.0	~45,000
VINNAPAS® B 30 SP	3.0 – 3.5	< 0.5	Pellets	< 1.0	~55,000
VINNAPAS® B 60 SP	3.5 – 5.0	< 0.5	Pellets	< 1.0	~70,000
VINNAPAS® B 60 FG	3.5 – 5.0	< 0.5	Powder	< 1.0	~70,000
VINNAPAS® B 100 SP	5.0 – 6.5	< 0.5	Pellets	< 1.0	~100,000
VINNAPAS® UW Grades⁹					
VINNAPAS® UW 1 FS	8.0 – 11.0	< 0.5	Beads	< 1.0	~145,000
VINNAPAS® UW 2 FS	11.0 – 13.5	< 0.5	Beads	< 1.0	~180,000
VINNAPAS® UW 4 FS	23.0 – 30.0	< 0.5	Beads	< 1.0	~305,000
VINNAPAS® UW 10 FS	35.0 – 55.0	< 0.5	Beads	< 1.0	~410,000
VINNAPAS® UW 25 FS	75.0 – 85.0	< 0.5	Beads	< 1.0	~540,000
VINNAPAS® Vinyl Acetate/Crotonic Acid Copolymer (CAS No. 25609-89-6)					
VINNAPAS® C Grades					
VINNAPAS® LL 8251	2.0 – 2.3	6.0 – 9.0	Flakes	< 0.5	~30,000
VINNAPAS® C 305	2.5 – 3.5	30.0 – 38.0	Flakes	< 0.5	~50,000
VINNAPAS® C 341	3.5 – 3.8	6.0 – 8.0	Flakes	< 0.5	~60,000
VINNAPAS® C 501	7.5 – 9.5	6.0 – 9.0	Flakes	< 0.5	~135,000
VINNAPAS® Vinyl Acetate/Vinyl Laurate Copolymer (CAS No. 26354-30-3)					
VINNAPAS® VL Grades					
VINNEX® RT 50	1.8 – 2.7	< 1.0	Hotmelt	< 1.0	~45,000
VINNEX® RT 200	5,000 – 25,000	< 1.0	Solution	n.m.	~35,000
VINNAPAS® B 100/20 VLE	3,700 – 4,700	< 0.5	Solution	~ 50 %	~185,000
VINNAPAS® B 500/20 VL	8.0 – 12.0	< 0.5	Blocks	< 1.0	~225,000
VINNAPAS® B 500/40 VL	8.0 – 12.0	< 0.5	Blocks	< 1.0	~320,000

¹ Conditions: 10% solution of VINNAPAS® solid resin in ethyl acetate, ASTM D 445-06, 20 °C; B 100/20 VLE which is a 50% solution in ethyl acetate is measured as such.

² WACKER method VPS 09

³ WACKER method VPS 07

⁴ SEC conditions: PS standard, THF; 60 °C; weight average

⁵ DIN EN ISO 1628-2; 1 wt % in acetone

⁶ Mettler softening point, ASTM D 3104

⁷ Bohlin high temperature viscosity, Bohlin CVO 120, heating rate 5 °C/min

⁸ DSC, Mettler DSC 821 E, heating rate 20 °C/min n.m. = not measurable

⁹ Abbreviations in product names read as follows:

SP = "special" with a very low residual monomer level < 5 ppm

FG = finely ground; contains 2% HDK® (pyrogenic silica)

as antiblocking agent FS = contains pyrogenic silica

K Value ⁵	Softening Point ⁶ [°C]	Melt Viscosity ⁷ at 120 °C [Pa s]	Glass Transition Temperature ⁸ [°C]	Food-Contact Compliance		
				EU 10/2011	FDA 175.300 FDA 175.105	
VINNAPAS® B Grades⁹						
~20	~85	~35	~33	●	● ○	VINNAPAS® B 1.5 SP
~26	~95	~130	~35	●	● ○	VINNAPAS® B 5 SP
~27	~101	~400	~38	●	● ○	VINNAPAS® B 14 SP
~31	~107	~1,500	~39	●	● ○	VINNAPAS® B 17 SP
~33	~113	~2,600	~40	●	● ○	VINNAPAS® B 30 SP
~40	~119	~4,000	~41	●	● ○	VINNAPAS® B 60 SP
~40	~119	~4,000	~41	●	● ○	VINNAPAS® B 60 FG
~43	~133	~8,500	~42	●	● ○	VINNAPAS® B 100 SP
VINNAPAS® UW Grades⁹						
~51	~155	~11,000	~42	●	● ○	VINNAPAS® UW 1 FS
~57	~167	~12,000	~42	●	● ○	VINNAPAS® UW 2 FS
~63	~197	~13,000	~43	●	● ○	VINNAPAS® UW 4 FS
~70	~220	n.m.	~43	●	● ○	VINNAPAS® UW 10 FS
~90	n.m.	n.m.	~43	●	● ○	VINNAPAS® UW 25 FS
VINNAPAS® C Grades						
~25	~101	~400	~38	●	○	VINNAPAS® LL 8251
~30	~120	~4,000	~45	●	○	VINNAPAS® C 305
~34.5	~118	~3,100	~40	●	○	VINNAPAS® C 341
~50	~146	~10,000	~43	●	○	VINNAPAS® C 501
VINNAPAS® VL Grades						
~27	~61	~15	~4	●	-	VINNEX® RT 50
~26	n.m.	n.m.	~4	●	-	VINNEX® RT 200
~45	n.m.	n.m.	~20	●	-	VINNAPAS® B 100/20 VLE
~50	115	~2,200	~20	●	-	VINNAPAS® B 500/20 VL
~51	85	~180	~0	●	-	VINNAPAS® B 500/40 VL

Please note:

These data are intended as a guide and should not be used in preparing specifications.

VINNAPAS® eco: The majority of VINNAPAS® grades that contain vinyl acetate can be certified as VINNAPAS® eco according to the mass balance approach. For more information on the mass balance approach and available VINNAPAS® eco grades, please visit www.wacker.com or contact your local representative.

SOLUBILITY AND COMPATIBILITY OF VINNAPAS® SOLID RESINS

Solubility of VINNAPAS® Solid Resins in Different Solvents and Monomers

Esters

Methyl acetate	●
Ethyl acetate	●
n-Propyl acetate	●
n-Butyl acetate	●
sec-Butyl acetate	●
iso-Butyl acetate	●
tert-Butyl acetate (TBAc)	●
Amyl acetate	●
Glycolic acid butyl ester	●
2-Methoxy ethyl acetate	●
2-Ethoxy ethyl acetate	●

Ketones

Acetone	●
Methyl ethyl ketone	●
Methyl isobutyl ketone	●
Cyclohexanone	●
Isophorone	●

Aromatic Hydrocarbons

Ethyl benzene	●
Toluene	●
Xylene	○
Styrene	●

Chlorinated Hydrocarbons

Methylene chloride	●
Chloroform	●
Trichloroethylene	●

Aliphatic Hydrocarbons

White spirit	○
Mineral oils	○

Acrylic Monomers

Methyl methacrylate (MMA)	●
1,3-Butanediol dimethacrylate (1,3-BDDMA)	●
1,4-Butanediol dimethacrylate (1,4-BDDMA)	●

- Soluble
- Partially soluble (depends on molecular weight)
- Insoluble

Alcohols

Methanol	●
Ethanol, anhydrous	○
Ethanol, 94%	●
Ethanol, 50%	●
i-Propanol, anhydrous	○
i-Propanol, 90%	●
n-Butanol	●
Cyclohexanol	○
Ethylene glycol	○
2-Ethoxy ethanol	●
2-Butoxy ethanol	●

Ethers

Diethyl ether	○
Tetrahydrofuran	●

- Soluble
- Partially soluble (depending on molecular weight)
- Insoluble

Compatibility of VINNAPAS® Solid Resins with Other Binders

Synthetic Polymers / Plastics

Polyethylene (PE)	○
Polypropylene (PP)	○
Polystyrene (PS)	○
Vinyl chloride – vinyl acetate copolymers	○
Ethylene butyl acrylate copolymers (EBA)	●
Ethylene vinyl acetate copolymers (EVA)	●
Polymethyl methacrylate (PMMA)	●
Polyesters	●
Nitrocellulose (soluble in alcohol)	○
Nitrocellulose (soluble in ester)	●
Polyvinyl methyl ether	●
Urea-formaldehyde	○
Unsaturated polyester resins (UP resins)	●
Vinyl ester resins (VE resins)	●
Epoxy resins (EP resins)	●

- Compatible
- Partial compatibility or compatibility depends on specific grade and/or ratio
- Incompatible

Natural and Hydrocarbon Resins

Alkyd resins	●
Rosin esters	●
Terpene resins	●
Hydrocarbon resins	●

- Compatible
- Partial compatibility or compatibility depends on specific grades and/or ratio
- Incompatible

Plasticizers

Plasticizers can be added to VINNAPAS® resins to increase flexibility and tack, to lower the heat-sealing temperature and to increase water resistance. Coatings and adhesives based on VINNAPAS® resins usually require only small amounts of plasticizer to increase their flexibility. Higher levels of plasticizer (20% or more) lower the softening point considerably, reducing the heat-resistance of the adhesives and increasing the surface tackiness of adhesives and coatings based on VINNAPAS®.

Recommended plasticizers for VINNAPAS® solid resins are:

- **Dibenzoates** E.g. diethylene glycol dibenzoate or dipropylene glycol dibenzoate
- **Citrates** E.g. tributyl-o-acetyl citrate (ATBC) or tris-(2-ethylhexyl) o-acetyl citrate (ATEHC)
- **Polymeric plasticizers** E.g. polyadipates
- **Triacetin** (glycerol triacetate)

Our unique VINNAPAS® VL resins are internally plasticized via the soft comonomer vinyl laurate. Traditional grades are VINNAPAS® B 500-40 VL, VINNAPAS® B 500-20 VL and VINNAPAS® B 100-20 VLE.

MELT VISCOSITIES OF VINNAPAS® SOLID RESINS

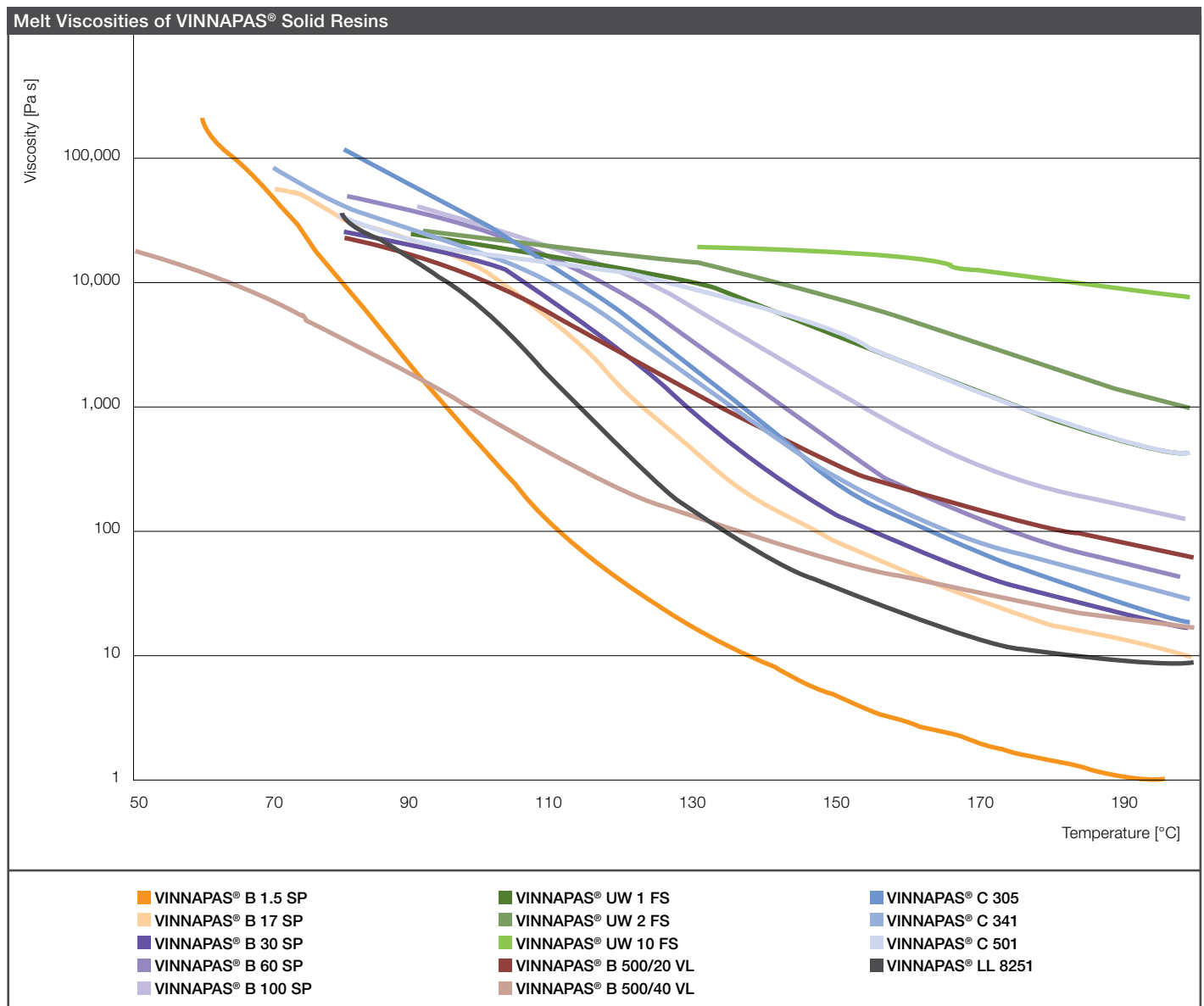

100% polymer, Bohlin high-temperature viscosity; Bohlin CVO 120, heating rate 5 °C/min

VISCOSITY OF VINNAPAS® SOLID RESINS IN ETHYL ACETATE

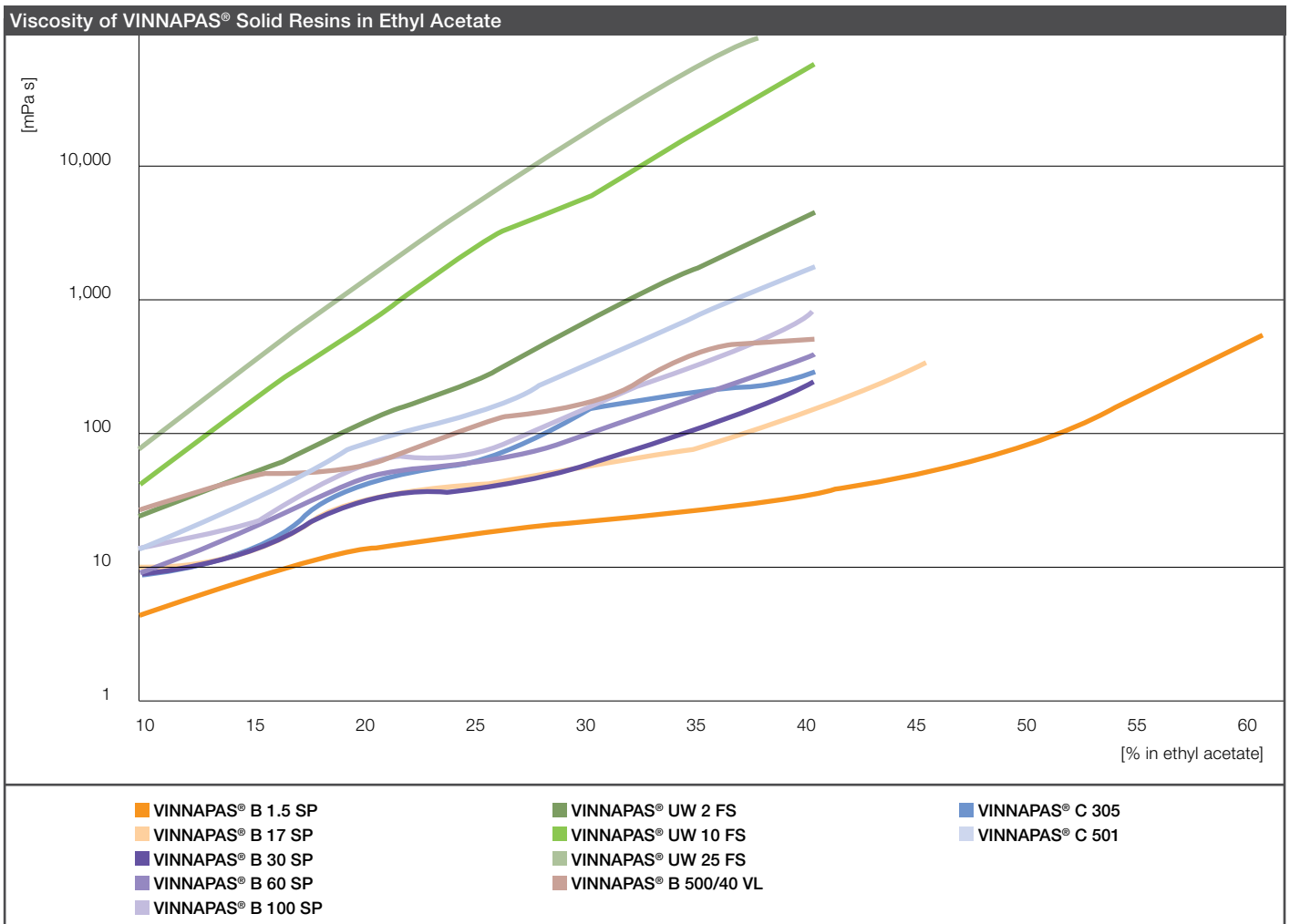

Brookfield viscosity at 23 °C/20 rpm

VISCOSITY OF VINNAPAS® SOLID RESINS IN STYRENE

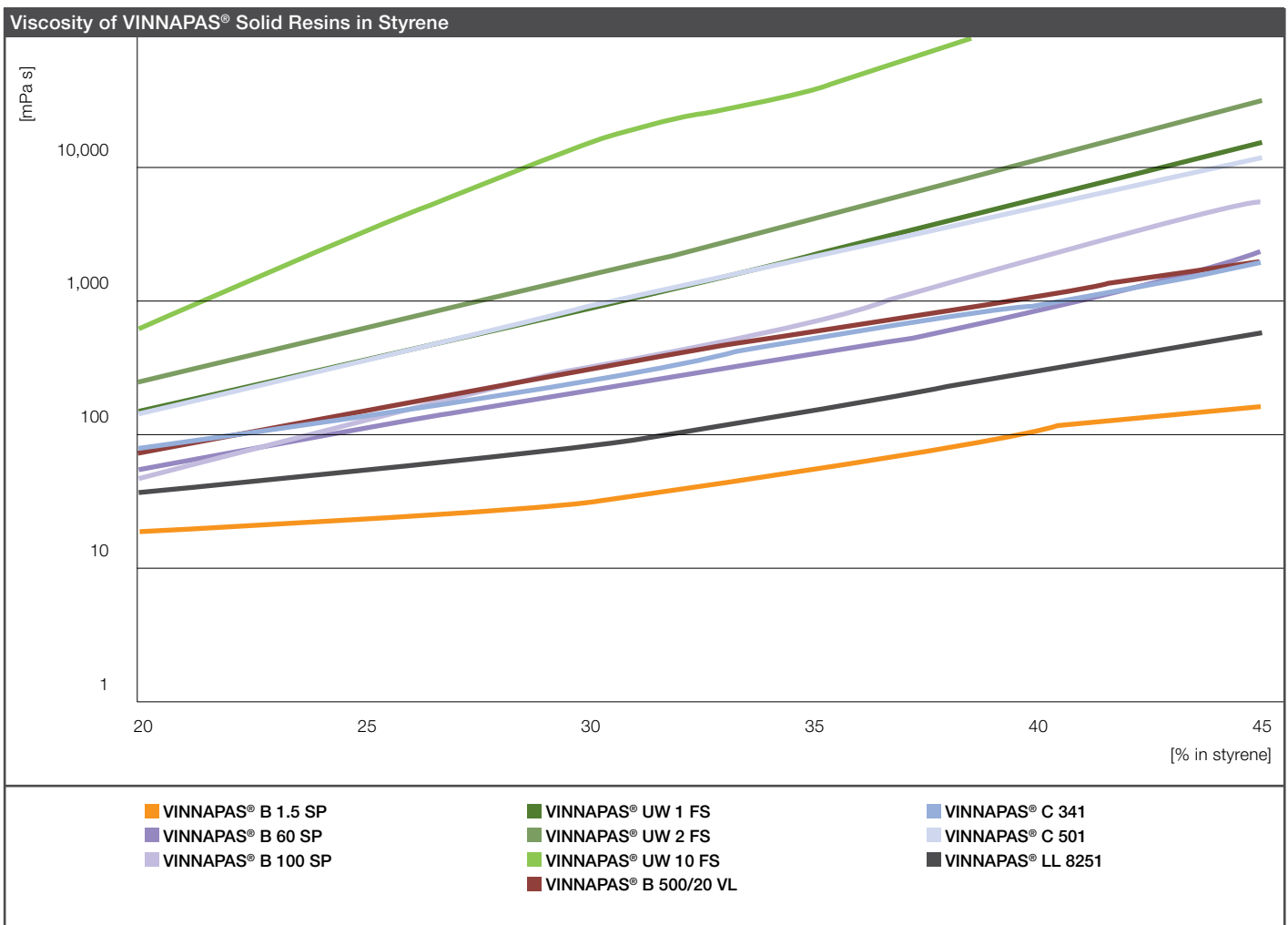

Brookfield viscosity at 23 °C/20 rpm

VINNAPAS® SOLID RESINS

APPLICATION AREAS

Applications				
Grades	Low-Profile Additive (LPA)	Solvent-Based Mastic & Parquet Adhesives	All-Purpose Adhesives	Tackifier/Modifier for Hot-Melt Adhesives
VINNAPAS® Homopolymer Polyvinyl Acetate (CAS No. 9003-20-7)				
VINNAPAS® B Grades				
VINNAPAS® B 1.5 SP		●	○	●
VINNAPAS® B 5 SP		○	○	●
VINNAPAS® B 14 SP		○	●	●
VINNAPAS® B 17 SP	○	○	●	●
VINNAPAS® B 30 SP	○	○	●	●
VINNAPAS® B 60 SP	●	○	●	●
VINNAPAS® B 60 FG	●	○	●	○
VINNAPAS® B 100 SP	●	○	●	●
VINNAPAS® UW Grades				
VINNAPAS® UW 1 FS	●	●	●	○
VINNAPAS® UW 2 FS	●	●	●	○
VINNAPAS® UW 4 FS	●	●	●	○
VINNAPAS® UW 10 FS	○	●	●	○
VINNAPAS® UW 25 FS	○	●	●	○
VINNAPAS® Vinyl Acetate/Crotonic Acid Copolymer (CAS No. 25609-89-6)				
VINNAPAS® C Grades				
VINNAPAS® LL 8251	●			
VINNAPAS® C 305				○
VINNAPAS® C 341	●			
VINNAPAS® C 501	●			
VINNAPAS® Vinyl Acetate/Vinyl Laurate Copolymer (CAS No. 26354-30-3)				
VINNAPAS® VL Grades				
VINNEX® RT 50	●			●
VINNEX® RT 200	●			○
VINNAPAS® B 100/20 VLE		●		
VINNAPAS® B 500/20 VL	○			○
VINNAPAS® B 500/40 VL	○			○

● Recommended ○ Suitable

VINNAPAS® eco: The majority of VINNAPAS® grades that contain vinyl acetate can be certified as VINNAPAS® eco according to the mass balance approach. For more information on the mass balance approach and available VINNAPAS® eco grades, please visit www.wacker.com or contact your local representative.

Acrylic Structural Adhesives	Coatings	Sound-Damping Sheets	Modifier for Thermoplastic Resins	Powder Injection Molding (PIM)	Nonwovens
VINNAPAS® B Grades					
	○				● VINNAPAS® B 1.5 SP
	○				● VINNAPAS® B 5 SP
	○				● VINNAPAS® B 14 SP
	○				● VINNAPAS® B 17 SP
	●		○	○	● VINNAPAS® B 30 SP
●	●		●	○	● VINNAPAS® B 60 SP
●	●		●	●	● VINNAPAS® B 60 FG
●	●		●		● VINNAPAS® B 100 SP
VINNAPAS® UW Grades					
●	●	○	●	●	VINNAPAS® UW 1 FS
●	○	●	●	●	VINNAPAS® UW 2 FS
	○	●	●		VINNAPAS® UW 4 FS
	○	●	●		VINNAPAS® UW 10 FS
	○	●	●		VINNAPAS® UW 25 FS
VINNAPAS® C Grades					
			○		VINNAPAS® LL 8251
	●		○		● VINNAPAS® C 305
			○		VINNAPAS® C 341
			○		VINNAPAS® C 501
VINNAPAS® VL Grades					
○	○		○		VINNEX® RT 50
○	○				VINNEX® RT 200
	●				VINNAPAS® B 100/20 VLE
			○		VINNAPAS® B 500/20 VL
			○		VINNAPAS® B 500/40 VL

VINNAPAS® is a highly effective thermoplastic anti-shrink (low-profile) additive for UP resin composites.

In addition to zero shrinkage, certain high temperature unsaturated polyester applications, such as SMC and BMC, require effective thickening to ensure easy handling of the composite and good glass-fiber distribution during mold flow: carboxylated VINNAPAS® C grades, in combination with magnesium oxide or calcium oxide, are the perfect thickening systems for unsaturated resin composites.

Carboxylated VINNAPAS® C grades, in combination with a thickening paste, result in a high and constant viscosity level. After maturation, this combination is ideal for preventing exudation of the thermoplastic resins. Carboxyl-free VINNAPAS® B and UW homopolymer grades are used when only moderate or no thickening of the UP resin composite is required. VINNEX® RT 50 and RT 200 are recommended for low and room temperature composites. Guide formulations are available on request.

Application	SMC	BMC	Pultrusion	RTM	Viscosity in styrene ¹ 40% in mPas
VINNAPAS® LL 8251	●	●	●	○	~ 300
VINNAPAS® C 341	●	●	●	○	~ 1,000
VINNAPAS® C 501	●	●	●	○	~ 6,500
VINNAPAS® B 60 sp	○	○	●	●	~ 1,000
VINNAPAS® B 100 sp	○	●	●	●	~ 2,000
VINNAPAS® UW 1 FS	○	●	●	○	~ 5,000
VINNAPAS® UW 4 FS	○	●	○	○	~ 66,000
VINNAPAS® UW 10 FS	○	●	○	○	~ 160,000
VINNEX® RT 50			○	●	~ 130
VINNEX® RT 200			○	●	~ 40

● Recommended
○ Suitable

BMC = Bulk molding compound;
SMC = Sheet molding compound;
RTM = Resin transfer molding
¹ Brookfield PHL 002/23 °C

Benefits of VINNAPAS® solid resins are:

- Zero shrinkage/expansion in FRP composites
- Excellent gloss and surface smoothness
- Effective thickening of SMC
- Easy processing and formulating
- Consistently high quality
- Good mechanical properties
- Rapid and complete solubility in styrene and acrylic monomers



LOW PROFILE ADDITIVES

VINNAPAS® solid resins are used as low-profile additives in fiber-reinforced plastics (FRP) composites to achieve zero-shrinkage, class A surface quality, full viscosity control and design flexibility.



Sheet Molding Compound (SMC)

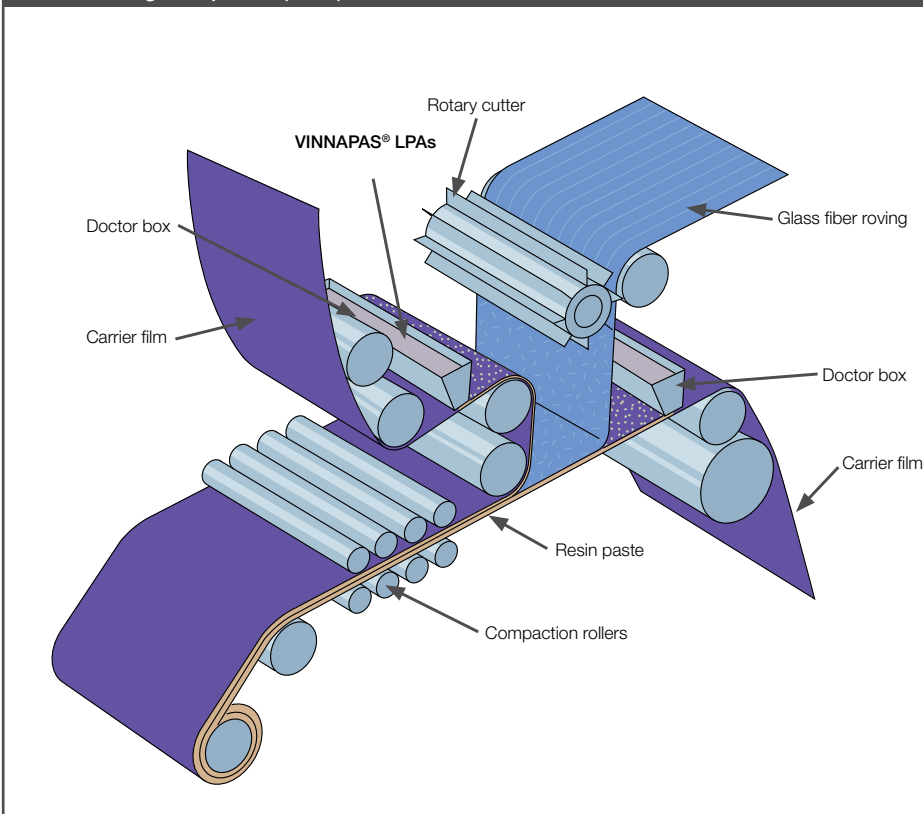

Typical SMC Formulation

Components	Parts by wt.
Unsaturated Polyester Resin	
Orthophthalic polyester resin (65% in styrene)	65.0
Additives	
VINNAPAS® PVAc (40% in styrene)	35.0
tert-Butyl perbenzoate	1.0
Peroxy ester	0.2
Pigment dispersion	10.0
Zinc stearate	2.0
Filler	
Calcium carbonate 3 μm	180.0
Glass Fibers	
50 mm chopped glass fibers, wt. %	27 – 29

Unless a low-profile additive is used in the manufacture of composite parts, high shrinkage will occur. The addition of VINNAPAS® resins minimizes this shrinkage to less than 0.05 %, resulting in extremely smooth, homogeneous surfaces.

VINNAPAS® Solution in Styrene

VINNAPAS® low-profile additives (LPAs) are mostly used as solutions in styrene. The VINNAPAS® polyvinyl acetate solid resins are readily soluble in styrene and thus enable you to prepare VINNAPAS® solutions in styrene according to your needs. For low styrene or styrene-free composites, VINNAPAS® resins can also be dissolved in alternative monomers such as 1,4-BDDMA.

Preparing a VINNAPAS® Solution in Styrene

Add the VINNAPAS® resin to the styrene while stirring well to prevent the formation of lumps during dissolution. This should usually be done at room temperature; some temperature increase during the dissolving process is normal and is due to shear friction. Protect the resulting solution from direct light during storage. Additional heat will increase the rate of dissolution. However, control the stability of the solution, because styrene monomer has a tendency to polymerize. While VINNAPAS® LPA solution typically contains 40% solids, this may vary with the molecular weight of the VINNAPAS® grade and the compound formulation.

Average figures for VINNAPAS® LPA solutions in styrene are:

- VINNAPAS® C Grades 40%
- VINNAPAS® B Grades 40 – 45%
- VINNAPAS® UW Grades 30 – 40%

The image shows several layers of wood-based panels with a dark wood grain finish. The panels are stacked and slightly offset, creating a sense of depth. The top panel is a solid, uniform dark brown color, while the layers below show a more natural wood grain pattern. The background is a solid blue color on the right side and white on the left side.

ADHESIVES

VINNAPAS® solid resins are used in the adhesives industry as binders for adhesives, due to their excellent adhesion to numerous substrates, such as paper, cartonboard, wood, textile, leather, glass, stone, metal and many plastics.

Wood-based panels with surface lamination are typical components of modern furniture such as kitchen fronts, side boards or cabinets.



Hot-Melt Adhesives

Polymeric binders, tackifier resins and waxes are the main components of typical hot-melt adhesives. Our thermoplastic VINNAPAS® solid resins, especially VINNAPAS® B resins, are suitable as tackifiers or modifiers in combination with rosin or hydrocarbon resins in hot-melt adhesive applications. VINNAPAS® B resins are colorless and odor-free food-grade materials. In hot-melt formulations, they offer an attractive cost/performance ratio and improve adhesion to certain critical substrates, such as PET and PP.

Polyurethane (PUR) hot-melt adhesives are one-component reactive polyurethane hot-melt adhesives and are e.g. applied in automobile manufacturing and construction. They are especially suitable for applications which need fast setting and positioning, water resistance, heat resistance and strong bonding strength. In recent years, more and more PUR hot-melt adhesives have relied on VINNAPAS® polyvinyl acetate homopolymers (PVAc) as tackifiers.

VINNAPAS® As Superior Tackifiers

PUR hot-melts consist of polyols including polyester and polyethers, isocyanates, tackifiers, additives and fillers. Tackifiers are added through grafted or physical blends in order to increase viscosity, improve heat resistance and initial bonding strength etc. As the tackifiers should be compatible with the prepolymer of PUR without any separation or sedimentation

acrylate, ethylene-vinyl acetate (EVA) and thermoplastic polyurethane (TPU) resins are a common choice. In the last years, polyvinyl acetate homopolymers (PVAc) have become popular due to the special benefits they offer. With VINNAPAS® PVAc resins you have these benefits at your hands.

Combining Benefits of Hot-Melts and Structural Adhesives

PUR hot-melt adhesives combine the initial setting speed of a hot-melt adhesive with the final strength of a structural adhesive. Bonding of PUR has two steps, first it builds up its green strength through a physical hardening process. Water molecules (from the substrate or the air) then trigger a chemical reaction which transforms the adhesive into an elastomer. After complete crosslinking for 24 to 48 hours, reactive hot-melt adhesives provide a stronger bond with superior resistance against moisture, heat and chemicals.

VINNAPAS® allows you to:

- Increase initial adhesion
- Modify hot-melt temperature and viscosity by choosing different PVAc
- Reduce shrinkage of PUR glue during cooling and curing which could lead to bonding failure
- Improve adhesion to wood

Therefore, PVAc solid resins are very suitable for woodworking and furniture surface decoration, such as edge banding, profile wrapping and flat lamination.

Acrylic Structural Adhesives

Free-radical-curing acrylic adhesives offer extremely strong adhesion to difficult substrates, as well as faster curing than, e.g. epoxies and polyurethanes. The performance of a structural adhesive is determined by the permanence of the bond between the adherends. The adhesive must shrink very little as it cures. VINNAPAS® solid resins reduce shrinkage during curing, thereby speeding up processing and providing a reliable bond.





VINNAPAS® solid resins are often used as binders in subfloor adhesives due to their excellent adhesion to wood and outstanding compatibility with VOC-exempt solvents.

Solvent-Based Adhesives

VINNAPAS® solid resins can be formulated with mild solvents such as esters, ketones or aqueous alcohols. In the US, acetone, methyl acetate and t-butyl acetate (TBAC) are so-called exempt solvents, as they make a negligible contribution to the formation of ground-level ozone and smog. The United States Environmental Protection Agency (US EPA) therefore excludes these exempt solvents from the regulatory definition of a VOC. With their excellent solubility in acetone, methyl acetate and t-butyl acetate, VINNAPAS® solid resins are therefore ideal binders for the formulation of VOC-compliant adhesives for the US market.

The VINNAPAS® B grades are suitable for adhesives which do not need to meet specific heat-resistance requirements. Increased heat resistance can be achieved by a combination of VINNAPAS® B grades and VINNAPAS® UW grades, along with a filler, such as calcium carbonate. For sprayable adhesives, low-molecular VINNAPAS® B grades are recommended. For manufacturing an adhesive containing VINNAPAS®, we recommend dissolving the VINNAPAS® resins or resin combination in a suitable solvent mixture under sufficient agitation, and then adding fillers, pigments, etc.

Construction adhesives must continue to perform well even under harsh conditions. VINNAPAS® solid resins provide the required properties.

Use of Plasticizers

Adhesives formulated with VINNAPAS® solid resins can be plasticized with typical dibenzoate plasticizers or with polymeric plasticizers, such as polyadipates, to obtain a highly flexible bond or to improve the low-temperature flexibility if required. Alternatively, VINNAPAS® B 100-20 VLE can be used. This is an internally plasticized copolymer with soft vinyl laurate comonomer, and is supplied as a ready-to-use 50% solution in ethyl acetate.

Application

VINNAPAS® based adhesives can be applied by conventional methods, such as brushing, roll coating, knife coating or spraying. Major application areas include parquet flooring, all-purpose and various mastic construction adhesives, e.g. subfloor and landscaping adhesives. Guide formulations are available on request.



COATINGS

Whether high binding power, water and abrasion resistance or exceptional flexibility is required, VINNAPAS® solid resins offer outstanding advantages in a wide range of coating systems.



Due to their outstanding clarity, VINNAPAS® solid resins are suitable for many applications in which natural resins are traditionally used.

In particular, the low-to-medium viscosity grades (B 5 SP – B 100) may serve as the synthetic resin component in cellulose nitrate lacquers (maple wood varnishes, lacquers for posters and labels). The viscosity and hardness of the lacquer can be varied over a wide range, depending on the VINNAPAS® grade selected. In connection with primers for porous materials, such as wood, plaster and masonry, the low-viscosity VINNAPAS® grades (e.g. B 1.5 SP, B 5 SP) are highly suitable for producing lacquers with high filler uptake and good spreading power. As the resins are totally colorless, the color of the primed surface remains unchanged. VINNAPAS® solid resins also ensure good adhesion and recoatability. In these applications, incorporating plasticizers may also be useful for improving the properties of the coating.

Advantages in a Wide Range of Coating Systems

VINNAPAS® C grades contain carboxyl functionality and are recommended for priming metal surfaces, e.g. aluminum foil, due to their excellent adhesion. VINNAPAS® C 305 is soluble in alkaline water, yet the dried film exhibits very good water resistance.

Also, VINNAPAS® C grades have outstanding adhesion to paper and corrugated board and are recommended for use as primers in the metallization of these substrates. They may be combined with non-functional

VINNAPAS® resins in order to adjust the adhesion and mechanical properties to the requirements of the application. The non-functional VINNAPAS® grades in the higher-viscosity range (UW grades) also have good metallizing properties.

VINNAPAS® VL grades are exceptionally flexible and adhere strongly to various plastic substrates, aluminum and glass. They are therefore eminently suitable for the production of so-called “soft touch” coatings or screen printing inks. VINNAPAS® VL grades have excellent compatibility with a wide range of different polymers, acting like migration-free polymeric plasticizers in such systems. Their main application field is in nitrocellulose-based systems.

VINNAPAS® has high binding power for pigments and fillers. For this reason, high pigment loading can be achieved when products based on VINNAPAS® are used. As they have a neutral pH, the VINNAPAS® B and UW grades tolerate not only neutral pigments and fillers, but also slightly alkaline pigments and fillers in the formulation.

Low- and medium-viscosity VINNAPAS® solid resin grades have proved suitable for the production of concrete sealing fluids and barrier coatings on gypsum sheets. In addition to reduced dusting resulting from improved abrasion resistance, these coatings offer good protection against penetration by oil, grease, humidity, etc. Examples of indoor applications are cellar floors and stairs. For outdoor applications, we recommend our VINNOL® resins.

A major problem in the automotive industry is the noise generated by the vibration of metal parts in the vehicle. Excessive noise can be reduced or eliminated by effective sound-damping material. VINNAPAS® UW resins can serve as the principal component for effective vibration-damping materials and sound-damping sheets.

The resins confer excellent sound-damping properties over a wide temperature range. Sheets formulated with VINNAPAS® UW resins yield more effective sound-damping and produce no toxic emissions and no fogging, compared to asphalt-containing sheets, due to their high molecular weight and chemical composition. Additional benefits exhibited by VINNAPAS®-based sound-damping sheets are excellent paintability, ease of handling, and reduced overall weight. Besides VINNAPAS® UW resin, formulations typically contain plasticizer, filler and carbon black. A wide range of fillers can be used, with calcium carbonate and mica very popular. Adding plasticizer allows the sound-damping sheets to be fine-tuned to the required flexibility and effective temperature range.

Wide Compatibility

VINNAPAS® resins are highly compatible with a broad spectrum of plasticizers. The most common plasticizers used here are phthalates, phosphates and glycol derivatives. The raw materials are mixed in an extruder and processed into thin sheets. Adhesion of these sheets to the metal can be boosted by applying common pressure-sensitive adhesives in the form of an emulsion. Guide formulations are available on request.

Benefits of VINNAPAS® solid resins are:

1. Luggage compartment: damping
2. Cabin side: side damping
3. Cabin floor: floor damping
4. Cabin top: top damping
5. Cabin tunnel: tunnel damping
6. Cabin front: side damping
7. Cabin door: door damping

SOUND-DAMPING SHEETS

Noise generated by the vibration of metal parts in automobiles can be reduced or eliminated by effective sound-damping materials containing VINNAPAS® UW resins.

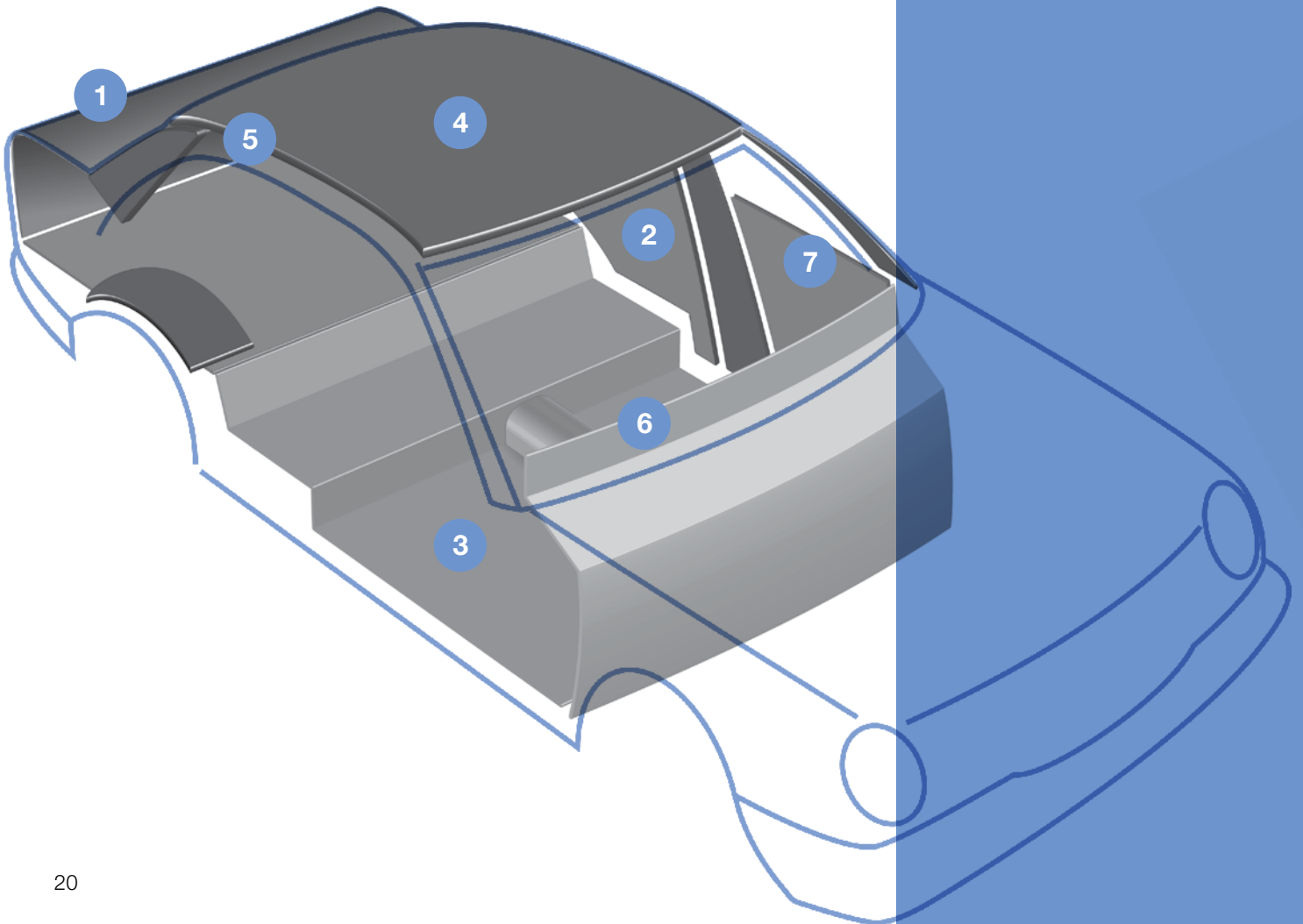

POWDER INJECTION MOLDING (PIM)

The negative effects of dusting and particle segregation in the PIM manufacturing process can be eliminated or reduced by using the right binder in the premixes, e.g. our VINNAPAS® B 100, UW 1 and UW 4 grades.

Powder injection molding is employed in the manufacture of, e.g. medical devices, aerospace or automotive components by the net-shaping technique. The use of an injection molding machine to shape metal or ceramic powder into specific designs allows complex product components to be produced in high volume.

The PIM industry is aware that premixes can vary in composition as a result of dusting and segregation. These effects are clearly evident in compositions that have a high alloy content.

However, they appear to be present in all mixtures, independent of alloy content. While dusting is a frequent visible indication, segregation due to particle migration is less apparent, but is nonetheless quite well known.

Reducing the Effects of Dusting and Segregation

Variations in composition due to dusting and segregation also give rise to variations in the mechanical and physical properties of blends and of parts made from these blends. It is difficult to quantify the effects of dusting and segregation. However, there is substantial evidence to suggest that these phenomena create both technical and economic problems for the PIM industry. In the former case, they limit the ability to blend metal powders without an additional binder. In the latter case, they may also cause dimensional variations that lead to part rejection, loss of productivity and poor overall economics.

A number of manufacturing options are available for eliminating or reducing the effects of dusting and segregation. The three most significant are: atomization of prealloys, diffusion bonding by annealing, and binder treatment of premixes.

The VINNAPAS® grades B 100, UW 1 and UW 4 are highly recommended for use as binder in these formulations.

Our products combine the following properties:

- Outstanding binding
- Excellent thermoplasticity
- Superior burn-out

VINNAPAS® SOLID RESINS

GENERAL INFORMATION

Dangerous Chemicals Regulations

VINNAPAS® B, UW, C and VL solid resins are classified as non-hazardous substances under GHS and therefore do not require labeling.

Storage of VINNAPAS® Solid Resins

To prevent caking, VINNAPAS® solid resins should not be stored at temperatures above 20 °C. Storage conditions must be dry and the material must be protected from direct sunlight.

Minimum Shelf Life

Please refer to the technical data sheet for the specific grade.

Packaging

Standard packaging for VINNAPAS® B, UW and C grades: paper bags, 25 kg net weight. 500 kg or 1000 kg big bags are available for most grades upon request.

Further information regarding individual products is available at www.wacker.com/vinnapas and from our WACKER offices.

VINNAPAS® solid resins are available as beads, flakes, powder and pellets.



EXPERTISE AND SERVICE NETWORK ON FIVE CONTINENTS

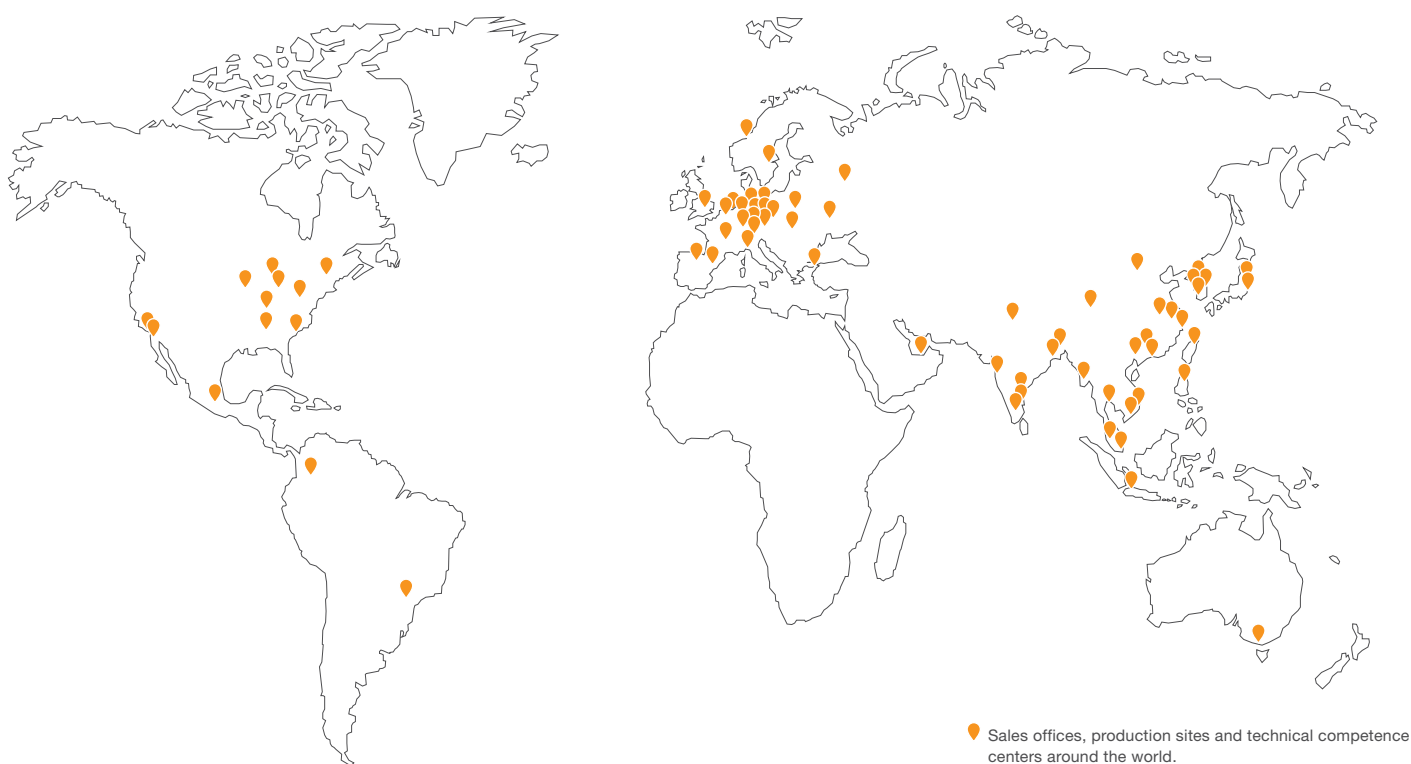

WACKER is one of the world's leading and most research-intensive chemical companies, with total sales of €6.21bn. Products range from silicones, binders and polymer additives for diverse industrial sectors to bioengineered pharmaceutical actives and hyperpure silicon for semiconductor and solar applications. As a technology leader focusing on sustainability, WACKER promotes products and ideas that offer a high value-added potential to ensure that current and future generations enjoy a better quality of life, based on energy efficiency and protection of the climate and environment.

Spanning the globe with 4 business divisions, we offer our customers highly-specialized products and comprehensive service via 26 production sites, 23 technical competence centers, 14 WACKER ACADEMY training centers and 52 sales offices in Europe, North and South America, and Asia – including a presence in China. With a workforce of some 14,400, we see ourselves as a reliable innovation partner that develops trailblazing solutions for, and in collaboration with, our customers. We also help them boost their own success. Our technical competence centers employ local specialists, who assist

customers worldwide in the development of products tailored to regional demands, supporting them during every stage of their complex production processes, if required. WACKER e-solutions are online services provided via our customer portal and as integrated process solutions. Our customers and business partners thus benefit from reliable service and comprehensive information to enable projects and orders to be handled fast, reliably and highly efficiently. Visit us anywhere, anytime around the world at: www.wacker.com



WACKER

Wacker Chemie AG
Hanns-Seidel-Platz 4
81737 Munich, Germany
www.wacker.com/contact

www.wacker.com

Follow us on:   

The data presented in this medium are in accordance with the present state of our knowledge but do not absolve the user from carefully checking all supplies immediately on receipt. We reserve the right to alter product constants within the scope of technical progress or new developments. The recommendations made in this medium should be checked by preliminary trials because of conditions during processing over which we have no control, especially where other companies' raw materials are also being used. The information provided by us does not absolve the user from the obligation of investigating the possibility of infringement of third parties' rights and, if necessary, clarifying the position. Recommendations for use do not constitute a warranty, either express or implied, of the fitness or suitability of the product for a particular purpose.